

1 TYPICAL 5'-0" HIGH AMEGO PANEL DETAILS
SK1 SCALE: 1/2"=1'-0"

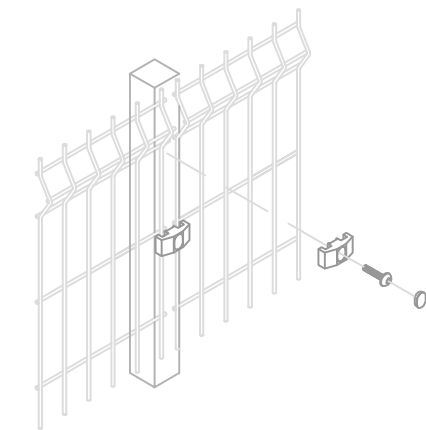

2 FINAL ASSEMBLY ISOMETRIC
SK1 SCALE: N.T.S.

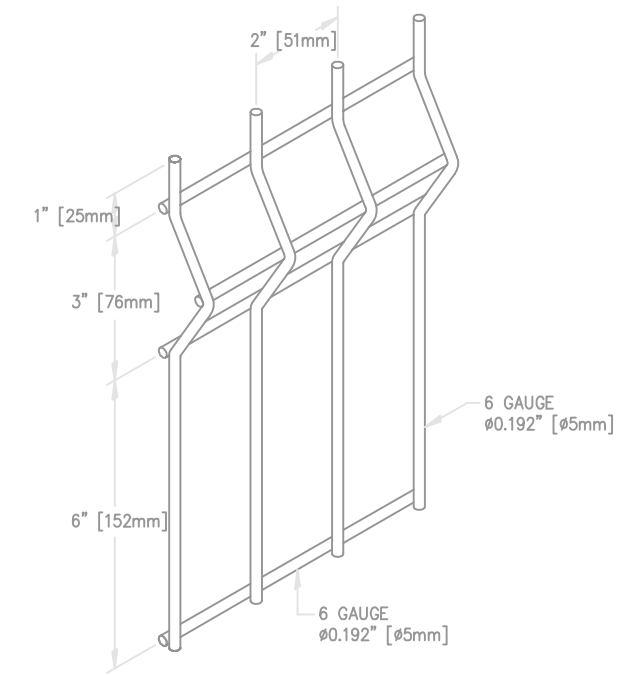

3 AMEGO PANEL ISOMETRIC
SK1 SCALE: 3"=1'-0"

THIS DRAWING IN DESIGN AND DETAIL IS THE SOLE PROPERTY OF METALCO (ATLANTIS PRODUCTS, INC.) AND MAY NOT BE USED FOR ANY PURPOSE WHATSOEVER OTHER THAN FOR OUR MANUFACTURING FACILITY AND INSTALLATION OF OUR PRODUCTS. THIS DOCUMENT OR ANY PART THEREOF MAY NOT BE REPRODUCED IN ANY MANNER WHATSOEVER AND SHALL BE RETURNED TO US UPON REQUEST. ALL RIGHTS RESERVED.

DRAWN BY: BHD	 586 TERRITORIAL DRIVE - UNIT H BOLINGBROOK, IL 60440 TEL. (630) 971-9680 FAX (630) 971-9860	SHEET NO: SK1
CHECKED BY: FC		
SCALE: AS NOTED	TITLE: TYPICAL 5'-0" H AMEGO PANEL DETAILS	
DATE: 07/18/11		