

1 TYPICAL "SELECT" PERFORATED RAILING SYSTEM
AI SCALE: 1"=1'-0"

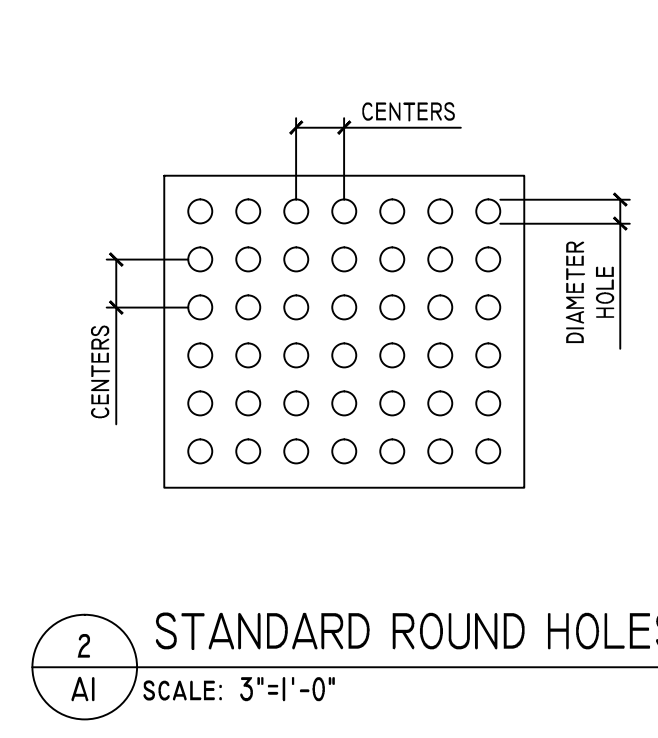

2 STANDARD ROUND HOLES
AI SCALE: 3"=1'-0"

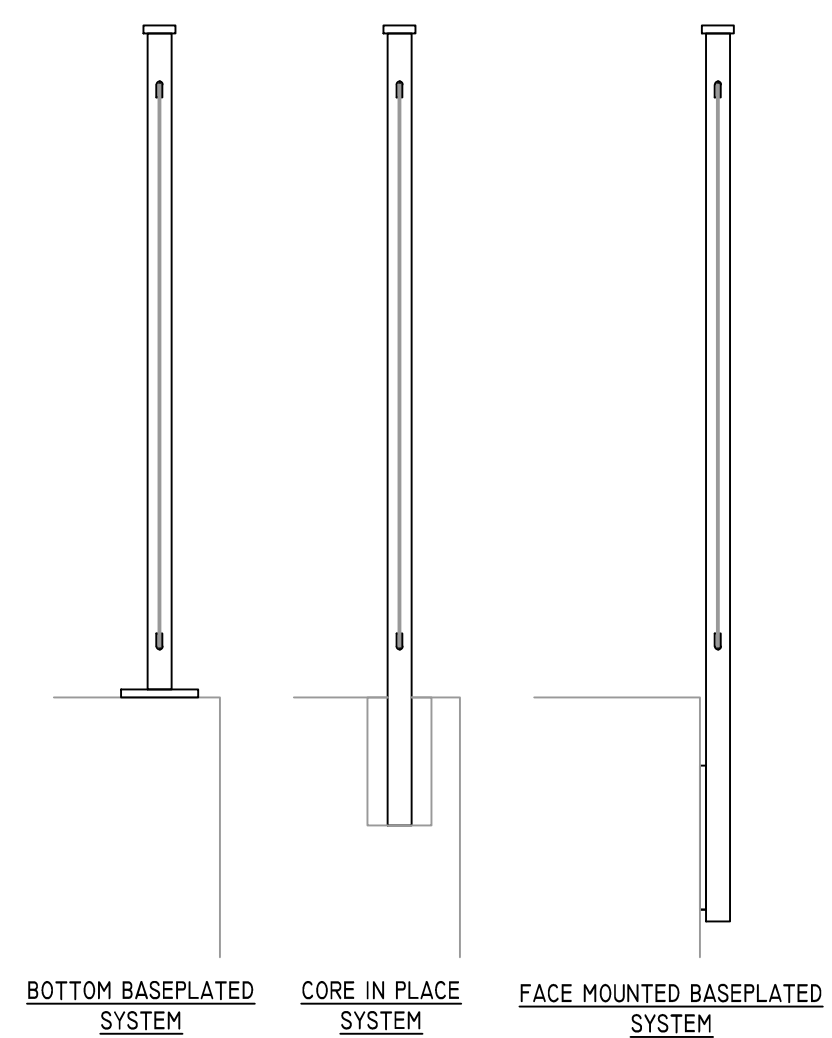
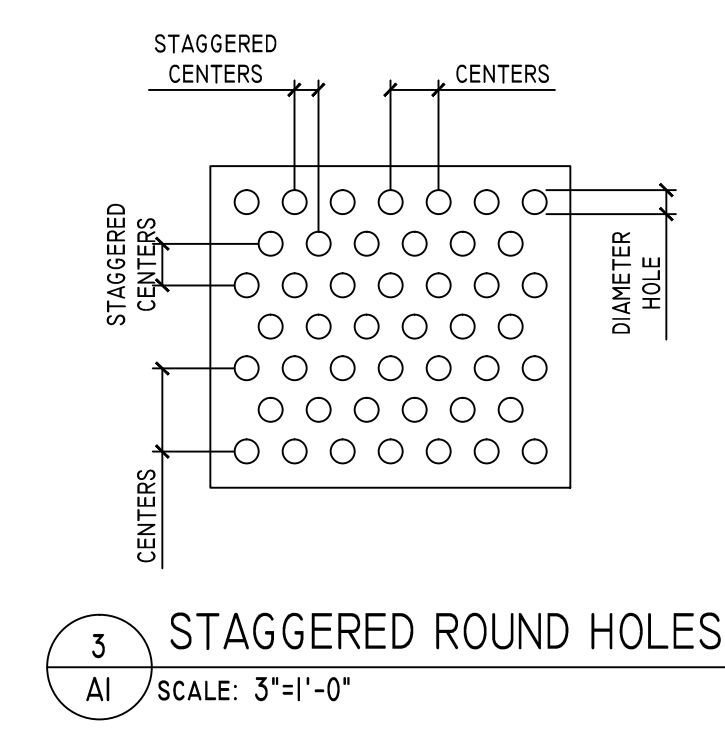

3 STAGGERED ROUND HOLES
AI SCALE: 3"=1'-0"

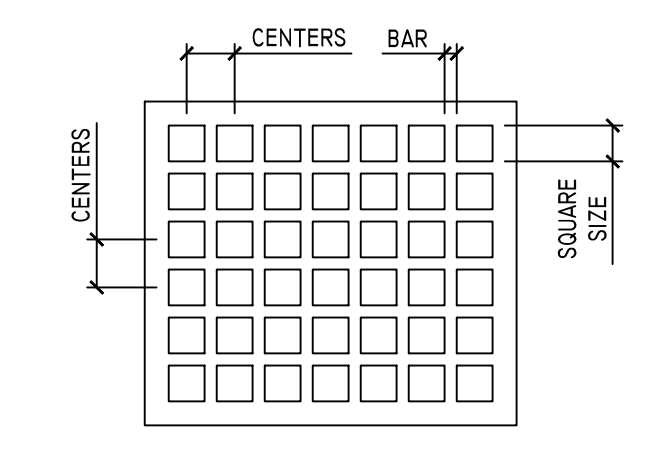

4 STANDARD SQUARE HOLES
AI SCALE: 3"=1'-0"

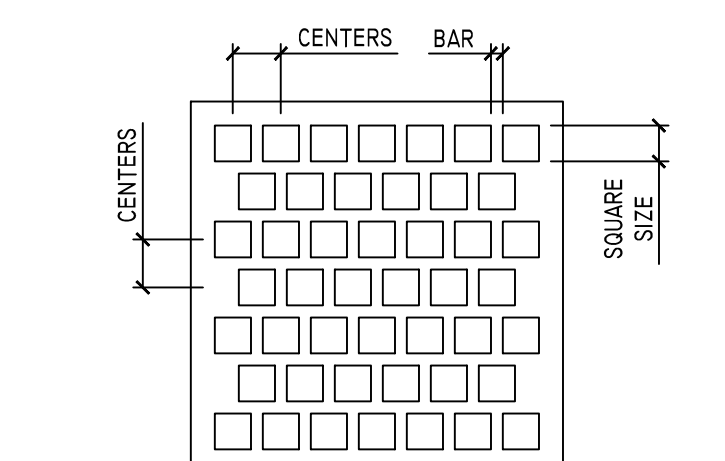

5 STAGGERED SQUARE HOLES
AI SCALE: 3"=1'-0"

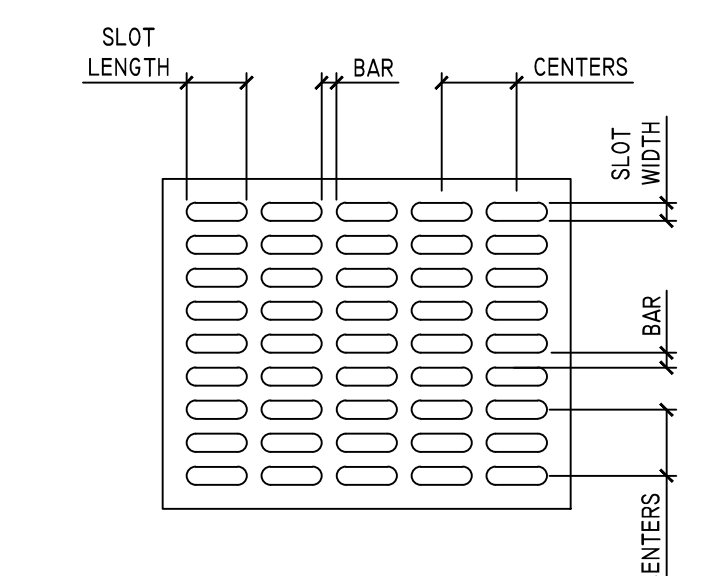

6 STANDARD SLOTTED HOLES
AI SCALE: 3"=1'-0"

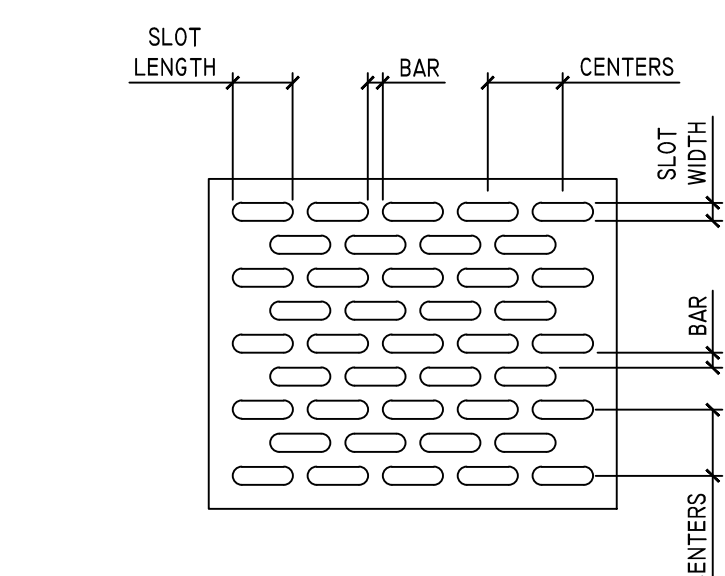

7 STAGGERED SLOTTED HOLES
AI SCALE: 3"=1'-0"

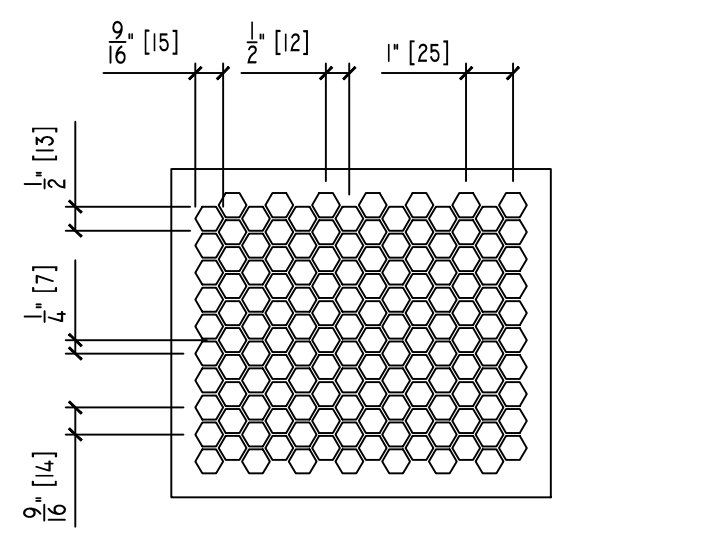

8 HEXAGONAL DECORATIVE
AI SCALE: 3"=1'-0"

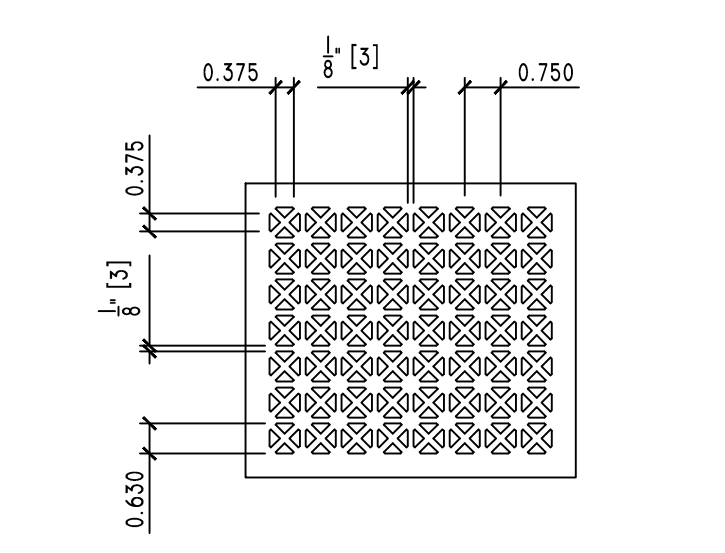

9 GRECIAN DECORATIVE
AI SCALE: 3"=1'-0"

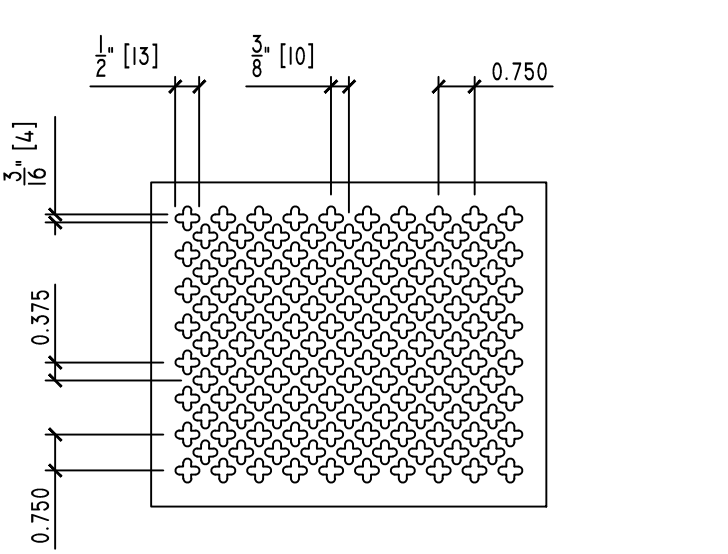

10 FULL CLOVERLEAF DECORATIVE
AI SCALE: 3"=1'-0"

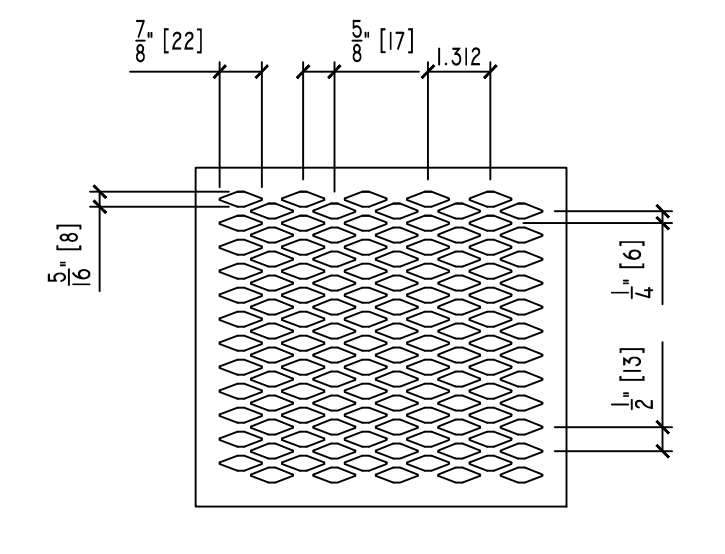

11 DIAMOND STAGGERED DECORATIVE
AI SCALE: 3"=1'-0"

THIS DRAWING IN DESIGN AND DETAIL IS THE SOLE PROPERTY OF METALCO (ATLANTIS PRODUCTS, INC.) AND MAY NOT BE USED FOR ANY PURPOSE WHATSOEVER OTHER THAN FOR OUR MANUFACTURING FACILITY AND INSTALLATION OF OUR PRODUCTS. THIS DOCUMENT OR ANY PART THEREOF MAY NOT BE REPRODUCED IN ANY MANNER WHATSOEVER AND SHALL BE RETURNED TO US UPON REQUEST. ALL RIGHTS RESERVED.

DATE SENT _____ INITIALS _____

REV. NO.	REV. BY	REV. DATE

CONTENTS:
"SELECT" PERFORATED RAILING INFILL PANEL DETAILS

metalco
566 TERRITORIAL DRIVE - UNIT H
BOLINGBROOK, IL 60440
TEL: (630) 971-9680 FAX: (630) 971-9860

PROJECT: "SELECT" PERFORATED RAILING SYSTEM
ADDRESS: _____

DRAWN BY: BHD
CHECKED BY: FC

SCALE: AS NOTED
DATE: 12/18/2014

JOB NO.: S-PERF

SHEET NO.: AI